

Connection box TB-11

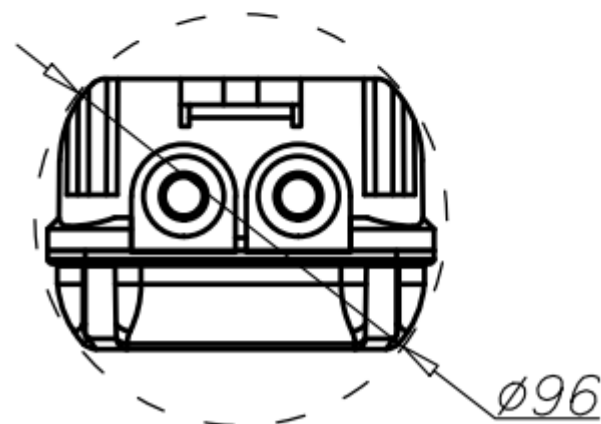

Connection box TB-11

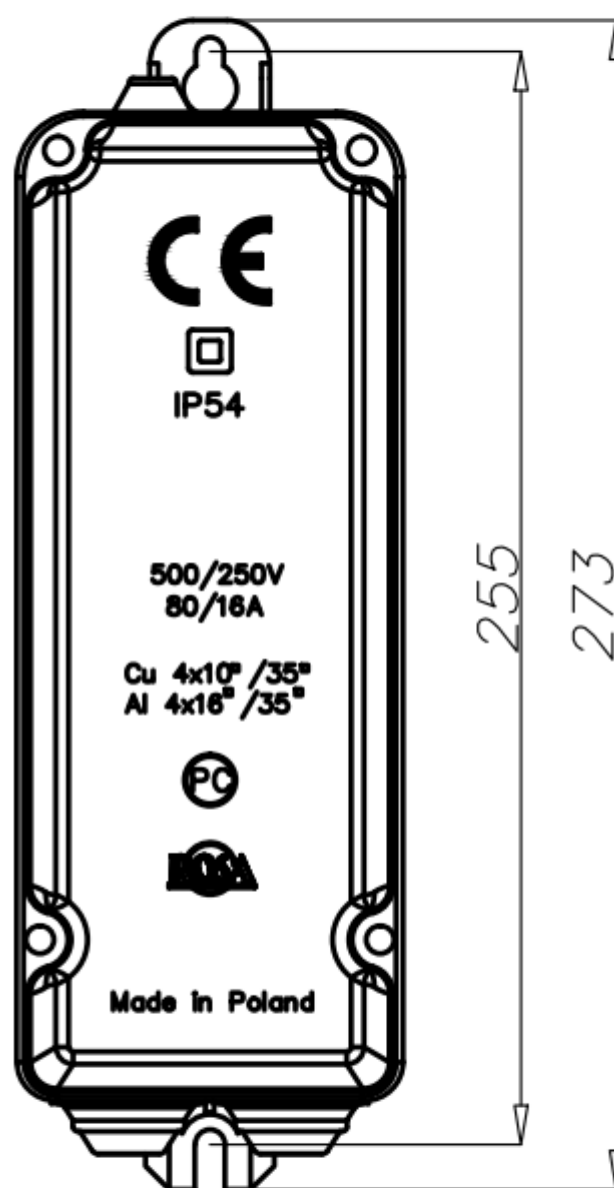
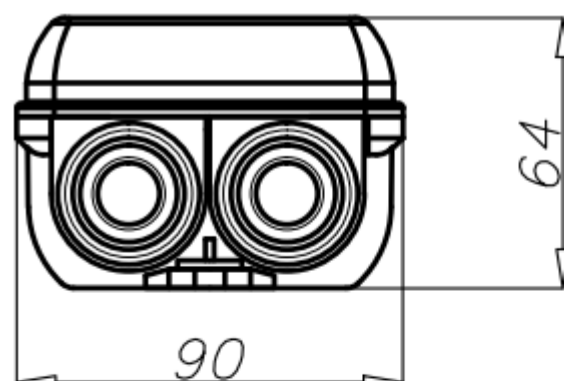
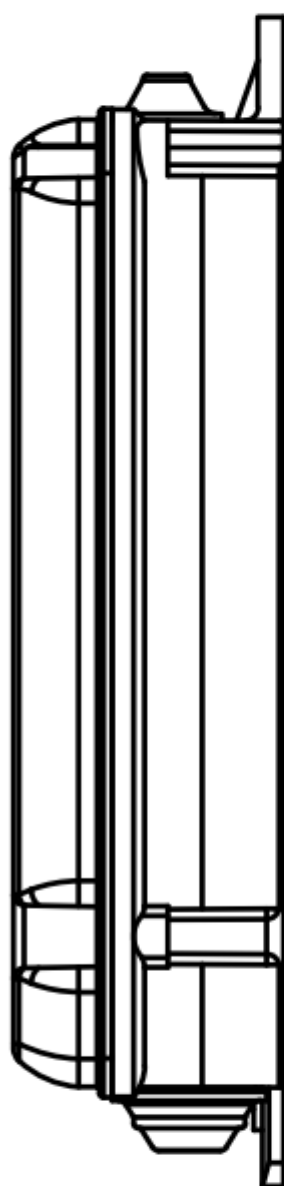

Technical data

Connection box	TB-11
Code	324011
Fuse sockets quantity	1
Insulation class	II
Protection degree	IP54
Rated insulation voltage [V]	500
Withstand stroke voltage rating [kV]	6
Current [A]	80
Range of wires crosssection and connecting cables	Connection box with 4 tracks for feeding cables with cross-section max. 3 cables, from 4 x 10 mm ² up 4 x 35 mm ² , luminaire's wire crosssection max 4mm ²
Material	integrated terminal strip – made of PTB material (butylene polyterephthalate), with high insulation parameters and high mechanical resistance; connection cover and clamp/cable protection – made of transparent polycarbonate; connection box base – made of polycarbonate reinforced by fibre glass, cable opening/outlets are protected with gaskets
Weight [kg]	0,67
Volume [kg]	1,7

- Low Voltage Directive LVD 2006/95/WE
- Norm PN-EN 60439-1

Fuse socket D01

Type of fuse socket	Code	Weight [kg]
D01/E14 6A	322006	0,01
D01/E14 10A	322010	0,01
D01/E14 16A	322016	0,01

