

# Aluminium extension arm WR-3/2

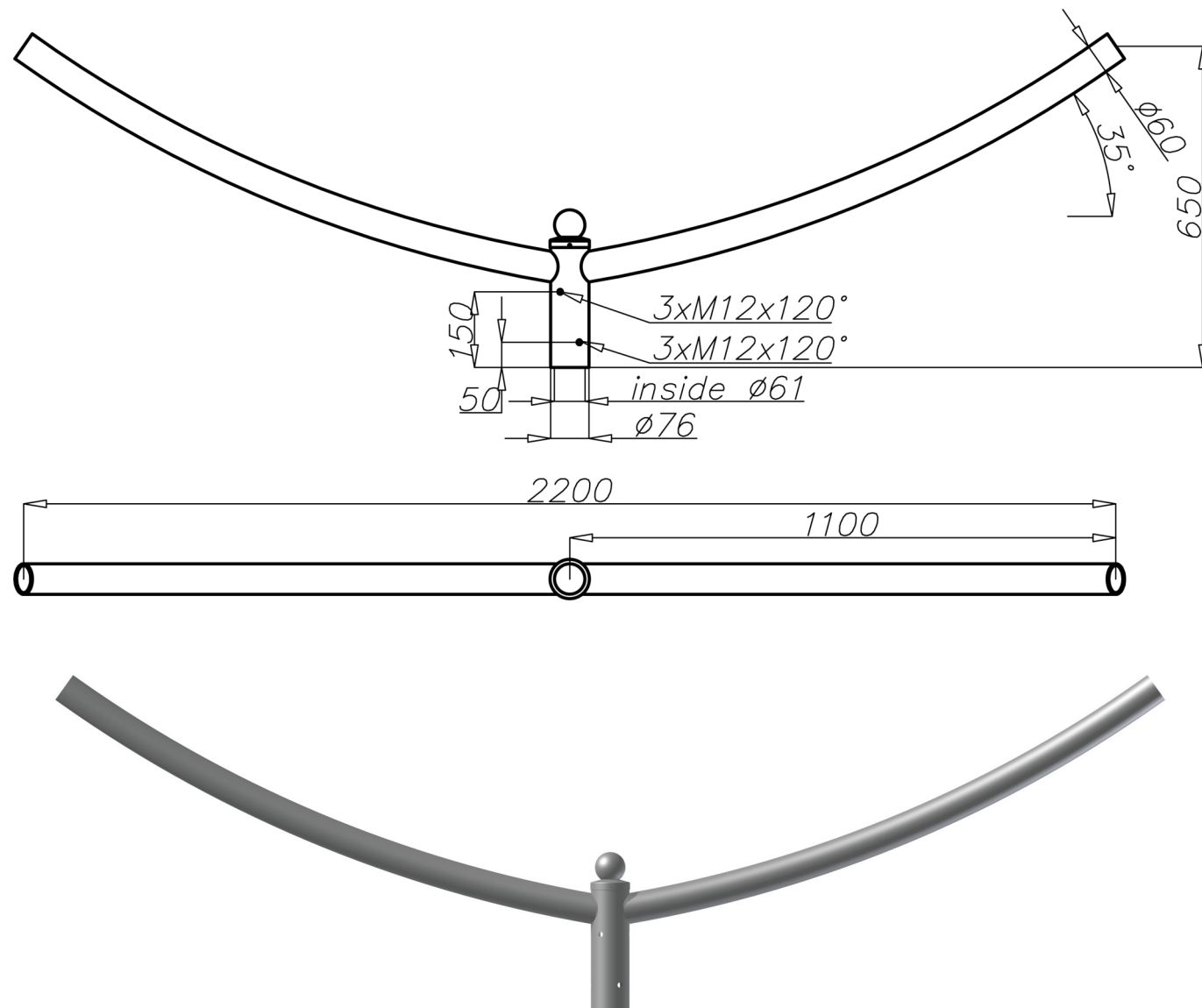

## Technical data

Extension arm	WR-3/2
Product code	472032
Application	aluminium columns with ending $\varnothing 60 \times 180$
Arm quantity	2
Net weight [kg]	4,9
Windage [m <sup>2</sup> ]	0,159
Volume [m <sup>3</sup> ]	0,07
Assembling diameter of luminaire [mm]	$\varnothing 60 \times 100$
Compatible luminaires	street luminaires

- anodizing in 12 colours
- option of powder painting in RAL colours (other colours available on request)
- packing: sleeve material
- CE certificate valid for use on poles manufactured by ROSA company