

Aluminium extension arm WR-15/2

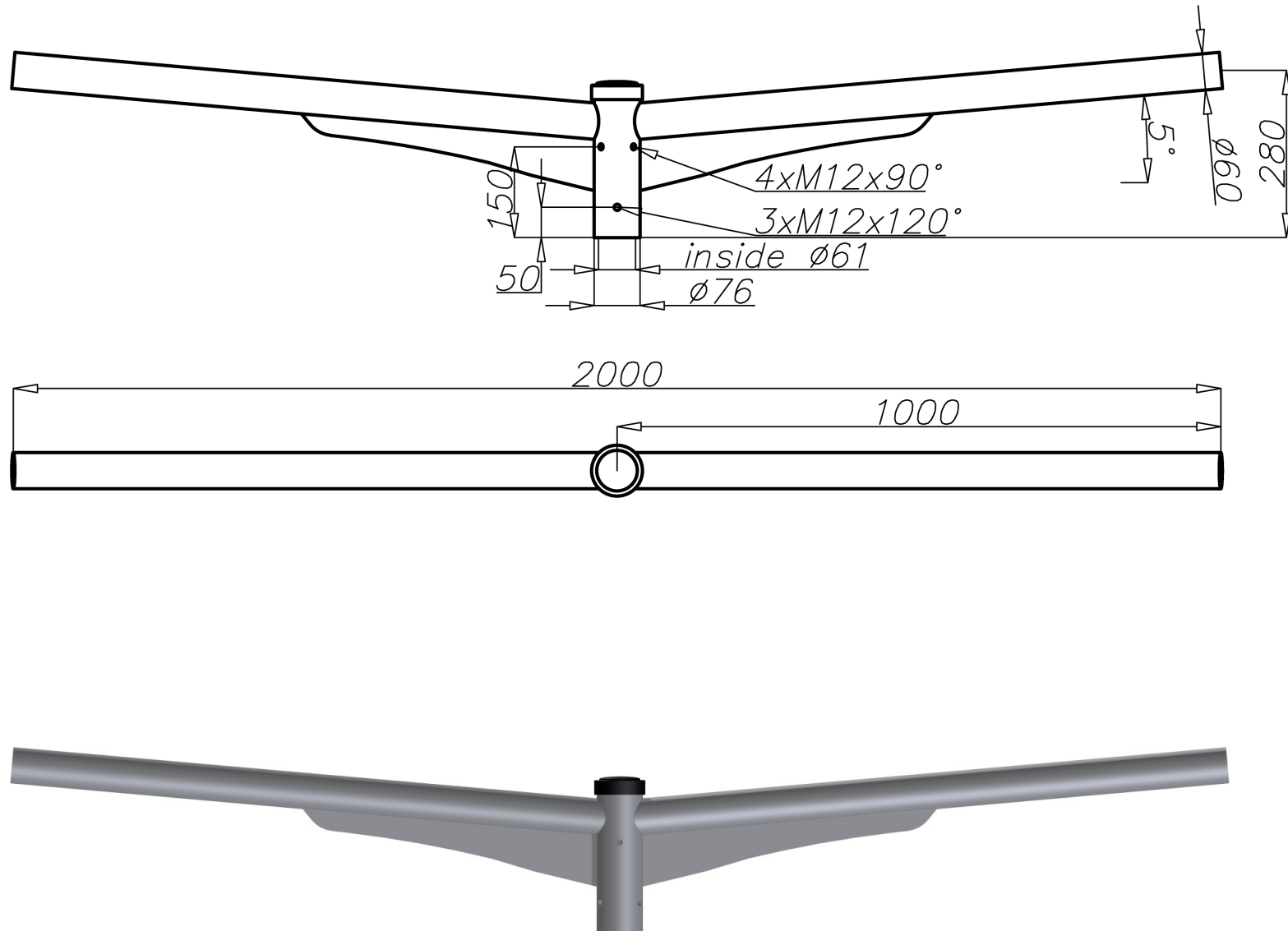

Technical data

Extension arm	WR-15/2
Product code	472152
Application	aluminium columns with ending $\varnothing 60 \times 180$
Arm quantity	2
Net weight [kg]	5,0
Windage [m ²]	0,183
Volume [m ³]	0,05
Assembling diameter of luminaire [mm]	$\varnothing 60 \times 100$
Compatible luminaires	street luminaires

- anodizing in 12 colours
- option of powder painting in RAL colours (other colours available on request)
- packing: sleeve material
- CE certificate valid for use on poles manufactured by ROSA company